







Molded Grating Selection & Details

Fibergate® Molded Grating

Brand	Depth	Mesh	Standard Panel Sizes	Wt. Per Sq. Ft.	Open Area
Airmesh®	1/2"	1-1/2" x 1-1/2" square	4' x 8' (<i>non-load carrying product</i>)	0.8 lb	87%
Multigrid®	1/2"	2" x 2" square	4' x 12', 4' x 15' (<i>must be fully supported</i>)	1.0 lb	82%
Micro-Mesh® 	1/2"	Top 3/4"±	4' 1" x 13' 1-3/4"	2.1 lb	43%
Fibergate®	5/8"	1" x 4" rectangular	12' x 4'	2.0 lb	58%
Fibergate	3/4"	1" x 4" rectangular	10' x 3', 8' x 4'	2.5 lb	69%
Fibergate	3/4"	1-1/2" x 1-1/2" square	3' x 10', 4' x 8', 4' x 12'	2.0 lb	70%
Micro-Mesh® 	1"	Top 3/4" sq, Btm 1-1/2" sq	4' x 12'	2.9 lb	44.4%
Ecograte®62 	1"	3/4" x 4" rectangular	4' x 12'	3.0 lb	62%
Fibergate	1"	1" x 4" rectangular	10' x 3', 8' x 4'	2.5 lb	69%
Fibergate	1"	1" x 4" rectangular	12' x 4'	2.6 lb	65%
Fibergate	1"	1-1/2" x 1-1/2" square	3' x 10', 4' x 8', 4' x 12'	2.5 lb	70%
Fibergate	1"	2" x 2" square	4' x 12'	1.7 lb	76%
Fibergate	1-1/4"	1-1/2" x 1-1/2" square	3' x 10', 4' x 8', 4' x 12', 5' x 10'	3.2 lb	70%
Fibergate	1-1/2"	1-1/2" x 1-1/2" square	3' x 10', 4' x 8', 4' x 12', 5' x 10'	3.8 lb	70%
High Load 	1-1/2"	1" x 2" rectangular	6' x 4', 4' x 8'	6.2 lb	48%
Micro-Mesh® 	1-1/2"	Top 3/4" sq, Btm 1-1/2" sq	2' x 2', 4' x 12'	4.5 lb	44.4%
Fibergate	2"	2" x 2" square	4' x 12'	4.0 lb	72%
High Load 	2"	1" x 2" rectangular	6' x 4', 4' x 8'	8.4 lb	48%

See page 8 for surface selection.

Grating Details

Airmesh® 1/2" Deep x 1-1/2" Square Mesh

# of Bars/ Ft of Width	Load Bar Width	Open Area	Load Bar Centers	Approximate Weight
8	1/8"	87%	1-1/2"	0.8 psf

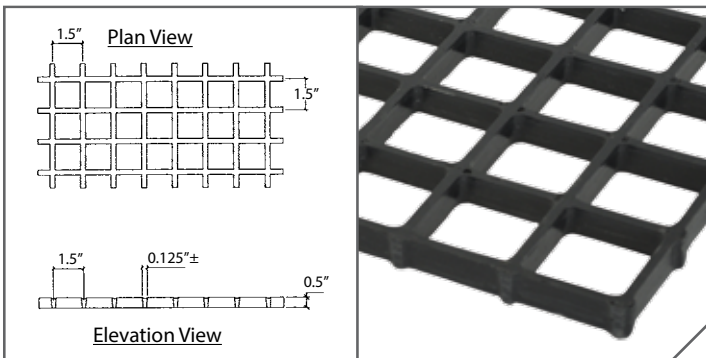

Designed for screening applications only

Multigrid® 1/2" Deep x 2" Square Mesh

# of Bars/ Ft of Width	Load Bar Width	Open Area	Load Bar Centers	Approximate Weight
6	3/16"	82%	2"	0.96 psf

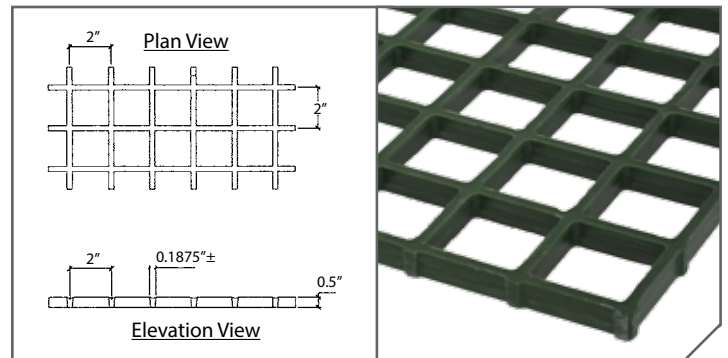

Must be fully supported in walking surface applications

Molded Grating Details

Micro-Mesh® 1/2", 1" & 1-1/2" Deep x 3/4" Sq Top Mesh



Depth	Square Top Mesh	Panel Size	# of Bars/ Ft of Width	Load Bar Width	Open Area	Load Bar Centers	Approximate Weight
1/2"	3/4"±	4' 1" x 13' 1-3/4"	8	1/4"	43%	1-9/16"	2.1 psf
1"	3/4"	4' x 12'	8	1/4"	44.4%	1-1/2"	2.9 psf
1-1/2"	3/4"	4' x 12'	8	1/4"	44.4%	1-1/2"	4.5 psf

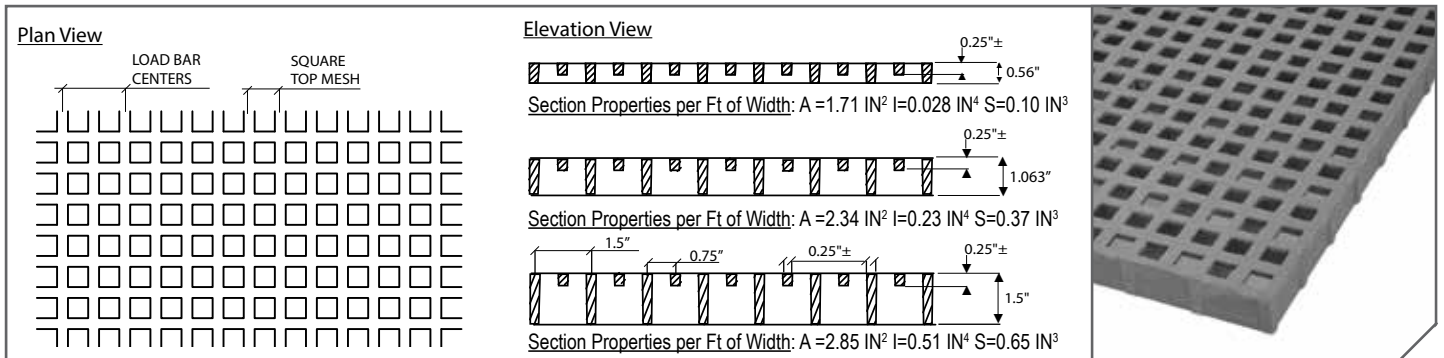

5/8" Deep x 1" x 4" Rectangular Mesh*

# of Bars/ Ft of Width	Load Bar Width	Open Area	Load Bar Centers	Approximate Weight
12	5/16"	58%	1"	1.98 psf

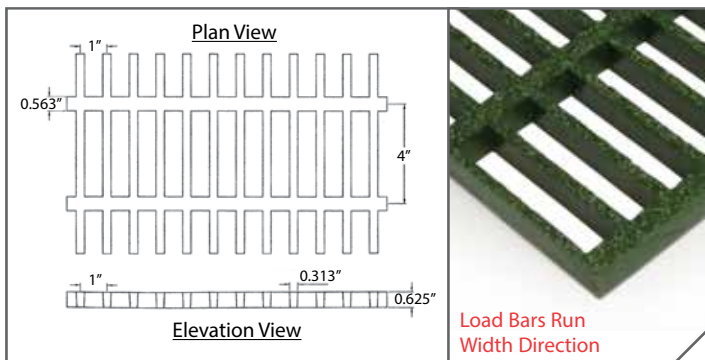

Section Properties per Ft of Width: A = 2.11 IN² I = 0.07 IN⁴ S = 0.22 IN³
*Not available with meniscus top surface (only grit)



1" Deep x 3/4" x 4" Rectangular Mesh

# of Bars/ Ft of Width	Load Bar Width	Open Area	Load Bar Centers	Approximate Weight
16	1/4"	62%	3/4"	3.0 psf

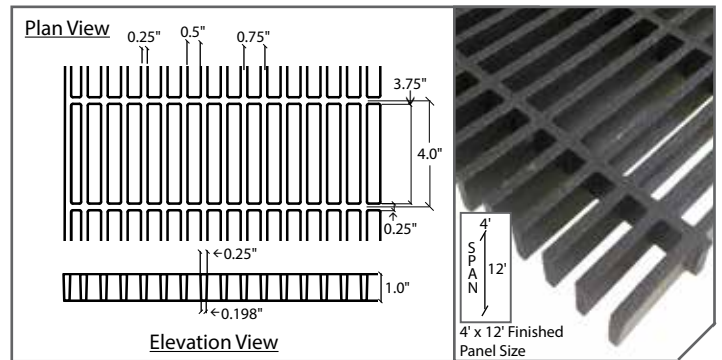

Section Properties per Ft of Width: A = 3.58 IN² I = 0.298 IN⁴ S = 0.573 IN³

1" Deep x 1" x 4" Rectangular Mesh*

Panel Sizes	# of Bars/ Ft of Width	Load Bar Width	Tie Bar Width	Open Area	Load Bar Centers	Approx. Weight
Design A 10' x 3' 8' x 4'	12	1/4"	3/8"	69%	1"	2.5 psf
Design B 12' x 4'	12	1/4"	1/2"	65%	1"	2.6 psf

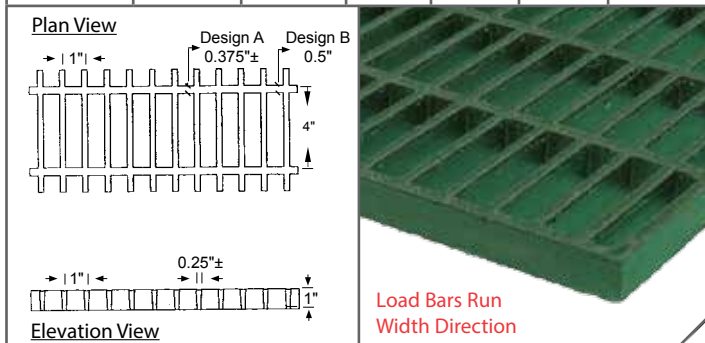

Section Properties per Ft of Width: A = 2.57 IN² I = 0.22 IN⁴ S = 0.43 IN³
*4' x 12' Panel Only - Not available with meniscus top surface (only grit)

1" Deep x 1-1/2" Square Mesh

# of Bars/ Ft of Width	Load Bar Width	Open Area	Load Bar Centers	Approximate Weight
8	1/4"	70%	1-1/2"	2.5 psf

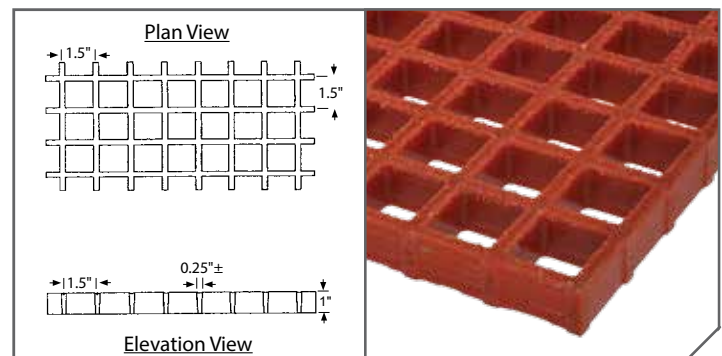

Section Properties per Ft of Width: A = 1.71 IN² I = 0.14 IN⁴ S = 0.29 IN³

Molded Grating Details

1" Deep x 2" Square Mesh

# of Bars/ Ft of Width	Load Bar Width	Open Area	Load Bar Centers	Approximate Weight
6	1/4"	76%	2"	1.7 psf

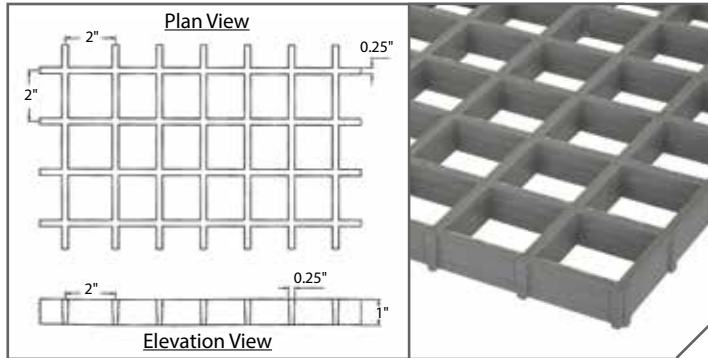

Section Properties per Ft of Width: $A = 1.27 \text{ IN}^2$ $I = 0.11 \text{ IN}^4$ $S = 0.21 \text{ IN}^3$

1-1/4" Deep x 1-1/2" Square Mesh*

# of Bars/ Ft of Width	Load Bar Width	Open Area	Load Bar Centers	Approximate Weight
8	1/4"	70%	1-1/2"	3.2 psf

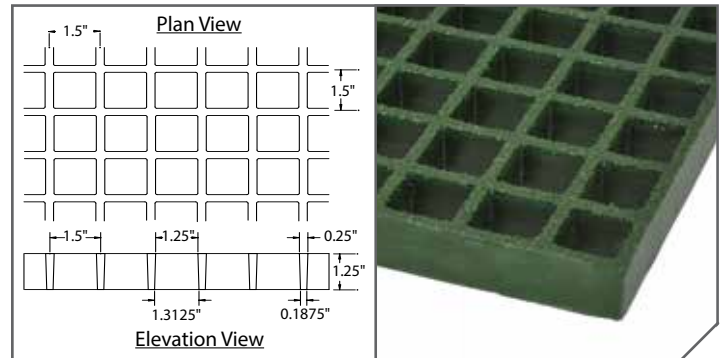

Section Properties per Ft of Width: $A = 2.16 \text{ IN}^2$ $I = 0.32 \text{ IN}^4$ $S = 0.48 \text{ IN}^3$

*Not available with meniscus top surface (only grit)

1-1/2" Deep x 1-1/2" Square Mesh

# of Bars/ Ft of Width	Load Bar Width	Open Area	Load Bar Centers	Approximate Weight
8	1/4"	70%	1-1/2"	3.8 psf

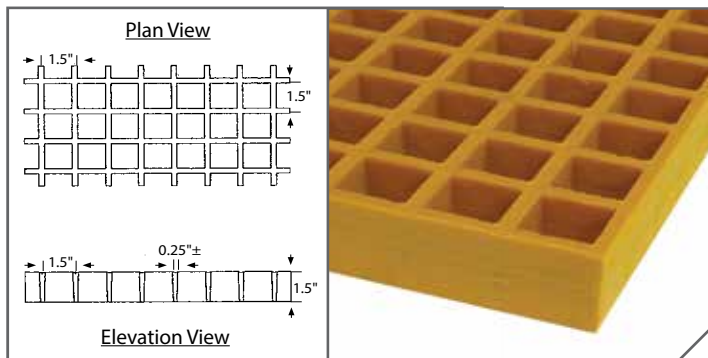

Section Properties per Ft of Width: $A = 2.85 \text{ IN}^2$ $I = 0.51 \text{ IN}^4$ $S = 0.65 \text{ IN}^3$

HLC 1-1/2" Deep x 1" x 2" Rectangular Mesh

# of Bars/ Ft of Width	Load Bar Width	Open Area	Load Bar Centers	Approximate Weight
12	0.43"	48%	1"	6.2 psf

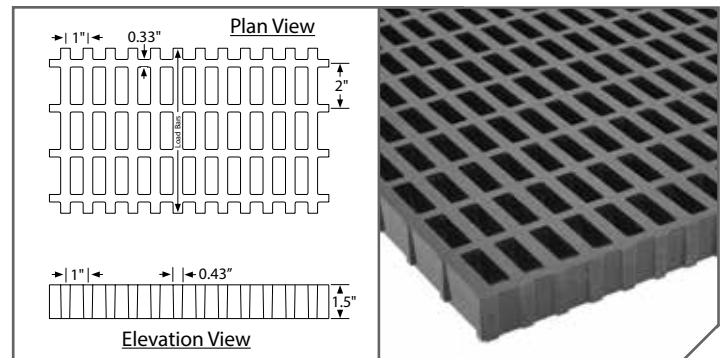

Section Properties per Ft of Width: $A = 7.45 \text{ IN}^2$ $I = 1.39 \text{ IN}^4$ $S = 1.80 \text{ IN}^3$

2" Deep x 2" Square Mesh

# of Bars/ Ft of Width	Load Bar Width	Open Area	Load Bar Centers	Approximate Weight
6	1/4"	72%	2"	4.0 psf

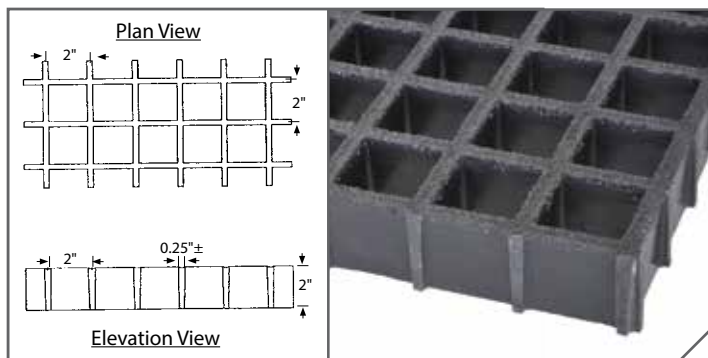

Section Properties per Ft of Width: $A = 2.88 \text{ IN}^2$ $I = 0.96 \text{ IN}^4$ $S = 0.94 \text{ IN}^3$

HLC 2" Deep x 1" x 2" Rectangular Mesh

# of Bars/ Ft of Width	Load Bar Width	Open Area	Load Bar Centers	Approximate Weight
12	0.48"	48%	1"	8.4 psf

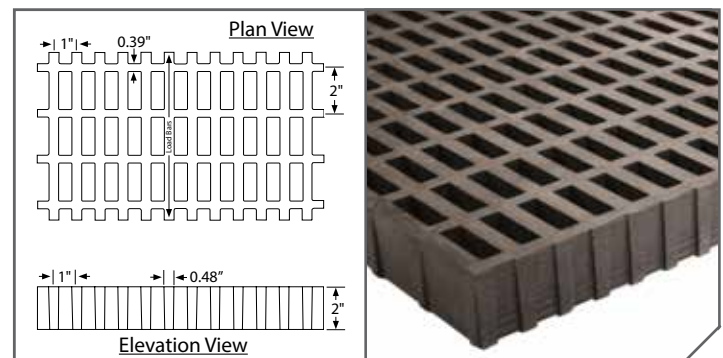

Section Properties per Ft of Width: $A = 10.26 \text{ IN}^2$ $I = 3.4 \text{ IN}^4$ $S = 3.27 \text{ IN}^3$

Molded Grating Resins

Corrosion in the workplace negatively impacts your bottom line. Each year, industrial plant executives eliminate expensive corrosion-related maintenance problems by switching to Fibergrate® molded grating. Various applications present different requirements so Fibergrate offers numerous standard resin systems to address multiple needs.

Fibergrate® Standard Resins

Vi-Corr®: A superior vinyl ester resin developed for reliable performance in the toughest environments. It offers outstanding resistance to a wide range of highly corrosive situations, from caustic to acidic. In fact, no other resin system can match the performance of Vi-Corr in highly acidic environments. **Vi-Corr has replaced VE-25.** Color: orange or dark gray. Flame spread: ASTM E84 rating of 25 or less. Certifications: DNV Type Approval No. F-16856; ABS Type Approval No. 01-HS34733-X; meets the USCG requirements for general fire rating*.

FGI-AM®: This improved food-grade isophthalic polyester resin system offers antimicrobial properties to inhibit the growth of bacteria on the surface of the composite to protect the product itself, along with the necessary corrosion resistance to meet the requirements of the food and beverage industry. This product is intended only for non-public health uses. Color: light gray or green. Flame Spread: ASTM E84 rating of 25 or less. Certifications: USDA Approvable.

Corvex®: This newly improved isophthalic polyester resin system outperforms a number of competitive fiberglass and metal products and meets the requirements for corrosion resistance found in industrial, chemical processing and water/wastewater applications. **This upgraded formulation has replaced IFR, CP-84 and FS-25 resins.** Color: yellow, dark gray, or dark green. Flame Spread: ASTM E84 rating of 25 or less. Certifications: DNV Type Approval No. F-16856; meets the USCG requirements for general fire rating*.

XFR: This eXtra Fire Retardant vinyl ester resin is recommended for use where the fire potential is high. Color: dark gray. Flame Spread: ASTM E84 rating of 10 or less, a level exceeded by no other resin system. Certifications: DNV Type Approval No. F-16856; meets the USCG requirements for general fire rating*.

ELS: This Extremely Low Smoke resin is an acrylic-modified polyester system that is ideal for tunnel, offshore, mass transit and other confined space applications. ELS exhibits low ignitability, low smoke generation and extremely low smoke toxicity. Color: dark gray. Flame Spread: ASTM E84: flame spread index of 25 or less, a smoke developed index of 100 or less and Fuel Contribution of 0. Certifications: DNV Type Approval No. F-16856; meets the USCG requirements for general fire rating*.

Super Vi-Corr®: This family of resin systems consists of more than 30 custom formulas engineered to provide corrosion control solutions in applications that are too severe for conventional FRP and other building materials. Each Super Vi-Corr resin was engineered for the best possible performance in specific chemical and/or elevated temperature environments. These systems exist for aggressive chemical service in reagents like solvents, acidic oxidizers, chlorine dioxide, sodium hypochlorite and liquid desiccants. Certain formulas are also suited for elevated temperature applications up to 400° F. Super Vi-Corr gratings are typically used for packing hold-downs and support in environmental and process scrubber applications. Color: natural - tan to beige. Flame Spread: non fire retardant, unless specified.

Specialty

Fibergrate also offers specialty resins custom designed to meet your specific needs. These special formulations are developed to address unique and demanding services and applications, as well as niche market needs (Super Vi-Corr family of resins).

We can engineer resin systems to address temperature, flame, smoke and toxicity requirements. Our HSUV resin system was developed to address the intense UV effects found in offshore applications. Fibergrate's custom formulations with low smoke/toxicity properties were engineered with the United States Navy for below-deck marine service.

Architectural Formulations: Fibergrate's standard formulations are designed for industrial and corrosive applications. Special formulations and colors are required to meet the unique demands of architectural, fountain and pool projects. Please contact Fibergrate for additional information.

Molded Grating Surfaces and Options

Slip Resistant Surfaces

Slips and falls are the second leading cause of industrial accidents. According to the National Safety Council, each injury related lost work day can cost \$50,000 to \$100,000. That is why Fibergrate developed two slip resistant surfaces for flooring and stair solutions. These surfaces include meniscus and integrally applied grit tops in the Fibergrate resins.

Available Surfaces for Molded Grating

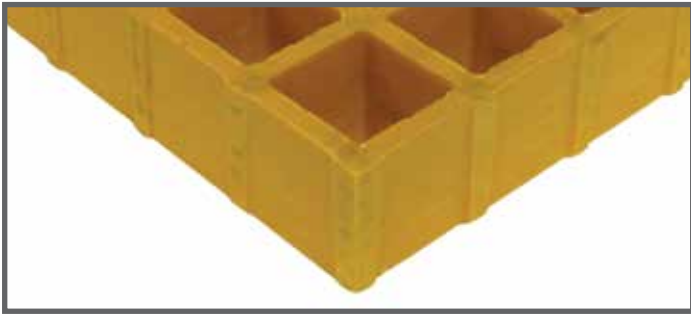

Meniscus Top: The concave surface of Fibergrate® meniscus top grating provides superior slip resistant footing in most environments including wet or oily conditions. It is the standard surface for most Fibergrate molded gratings.

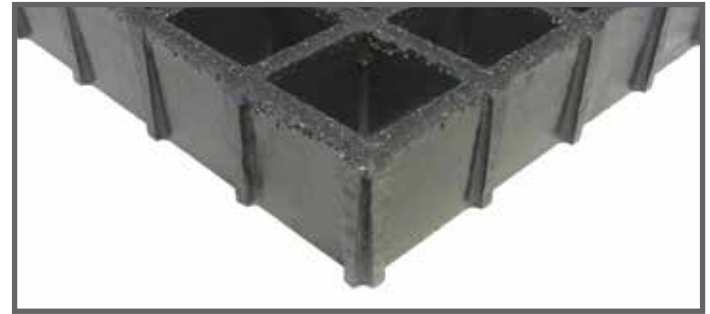

Integrally Applied Grit Top: The optional grip top of Fibergrate® grating has a quartz grit which is integrally applied, cured and sealed onto the surface providing excellent slip resistant footing.

Please note - The following molded grating panels are **only available with the grit top** surface (meniscus top not an option):
5/8" deep, 1" x 4" rect. mesh, 12' x 4' panel; 1" depth, 1" x 4" rect. mesh, 12' x 4' panel; 1-1/4" deep, 1-1/2" square mesh

Specialty Molded Products

FRP Conductive Surface: Fibergrate® Conductive Surface Grating properties are based on the requirements found in [NFPA 77, Recommended Practice on Static Electricity, 2000 Edition](#). The specification values below are minimum values based upon the guidance of NFPA 77, and apply only when the product is clean and grounded. Fibergrate recommends a minimum of 4 grounding attachments at the corners of a section of grating.

- Average Surface Resistivity – 2.5×10^3 ohms to 1×10^6 ohms per lineal foot
- Average Resistance to Ground – $<10^8$ ohms

Fibergrate HF Molded Grating: Fibergrate has combined a premium-grade vinyl ester resin and exotic reinforcements to manufacture the only molded grating system suitable for service in harsh hydrofluoric acid applications. HF Molded Grating, a non fire retardant system, can see service in applications that would cause premature failure in most traditional molded grating systems.

NSF® Standard 61-Certified Molded Gratings: Fibergrate now manufactures NSF Standard 61-Certified grating. NSF formulated molded grating is available by special order in dark gray and light gray colors. Molded grating is also available in all of the molded grating mesh patterns and grating thicknesses, except Ecograte® and 4 x 12 Micro-Mesh® panels. Our NSF Standard 61-Certified structural shapes, handrails, ladders and pultruded components can be combined to create valuable, long-lasting stairways, walkways and platforms.

Custom Molded Products

Fibergrate has the capability to offer molded grating configurations designed/manufactured to meet your unique application requirements. Fibergrate's custom services include special molded grating configurations as well as custom hand-lay-up (HLU) products for industrial and architectural applications designed to meet your specific performance requirements.